

Personal Computer Connection Methods

The various PC connection methods are:

- ➔ Ports
- ➔ Personal Computer Connections
- ➔ Serial Connections
- ➔ Parallel Connections
- ➔ Universal Serial Bus (USB) Connections
- ➔ IEEE 1394 and FireWire Connections
- ➔ Small Computer Systems Interface (SCSI) Connections
- ➔ Parallel ATA (PATA) Connections
- ➔ Serial ATA (SATA) Connections

Ports

A port is a hardware connection interface on a personal computer that enables devices to be connected to the computer.

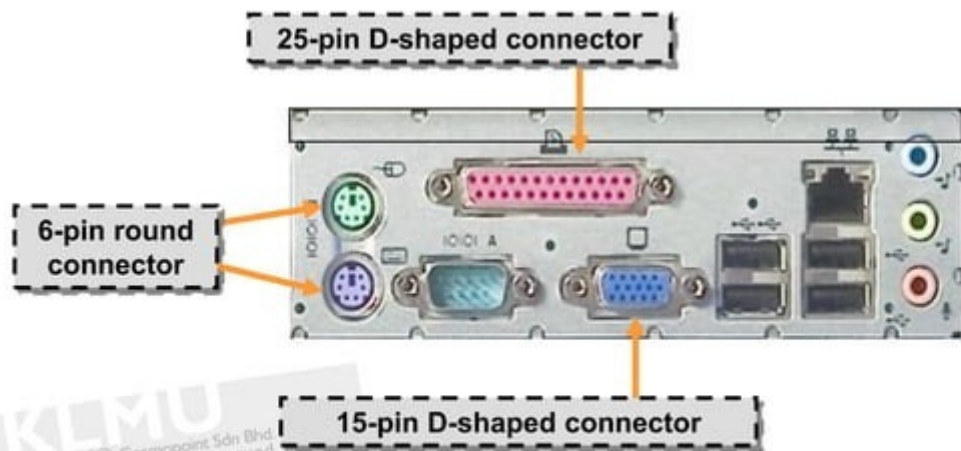

Enable devices to be connected to a personal computer.

Personal Computer Connection

A ***personal computer connection*** is a means by which a personal computer component is attached to other components to provide computing capabilities.

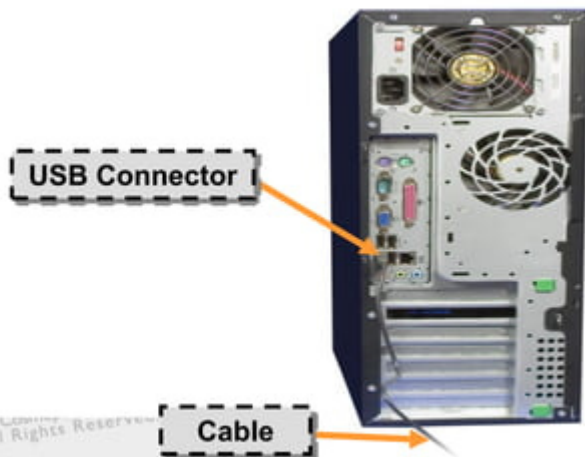

Serial Connections

A **serial connection** is a personal computer connection that transfers data one bit at a time over a single wire.

25-pin serial port
on a serial device



25-pin end of serial cable connects to modem
and 9-pin end connects to computer's serial port



Parallel Connections

A ***parallel connection*** is a personal computer connection that transfers data eight bits at a time over eight wires and is typically used to connect a printer to a system unit.

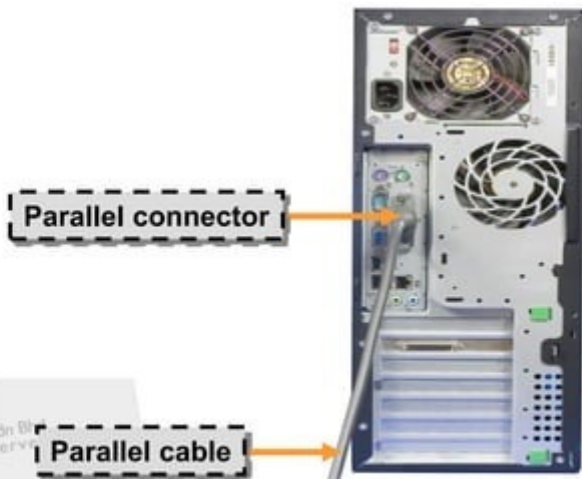

USB Connections

A **USB connection** is a personal computer connection that enables you to connect multiple peripherals to a single port with high performance and minimal device configuration.

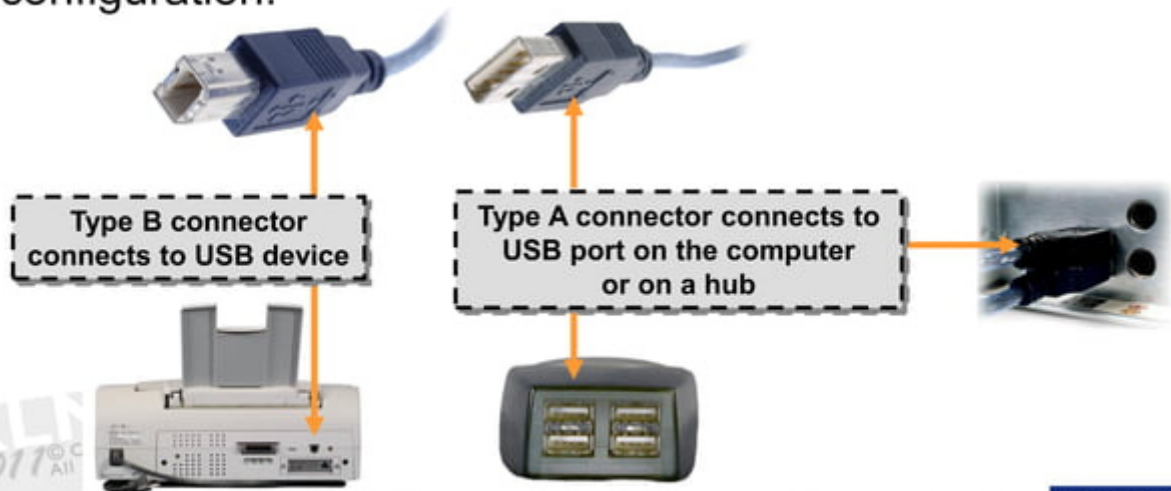

IEEE 1394 and FireWire Connections

A **FireWire connection** is a personal computer connection that provides a high-speed interface for peripheral devices that are designed to use the IEEE 1394 standard.



FireWire port

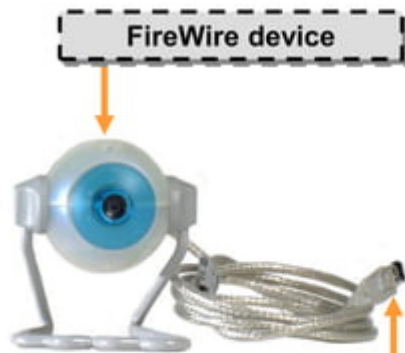

FireWire device

FireWire 6-pin connector

Small Computer Systems Interface (SCSI) Connections

A **SCSI connection** is a personal computer connection that connects internal and external components to the system unit and provides for high-speed data transfer.

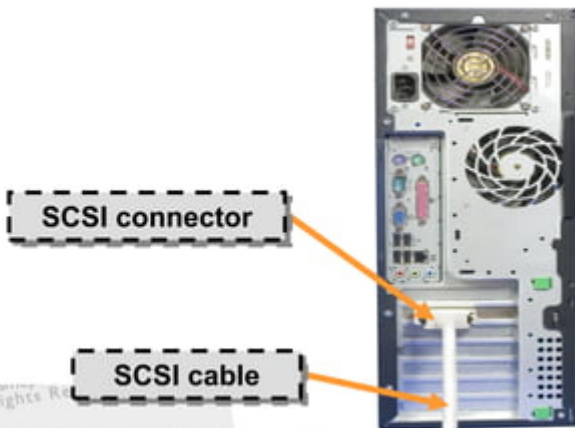

Parallel ATA (PATA) Connections

A ***PATA connection*** is a personal computer connection that provides a parallel data channel from a disk controller to the disk drives.

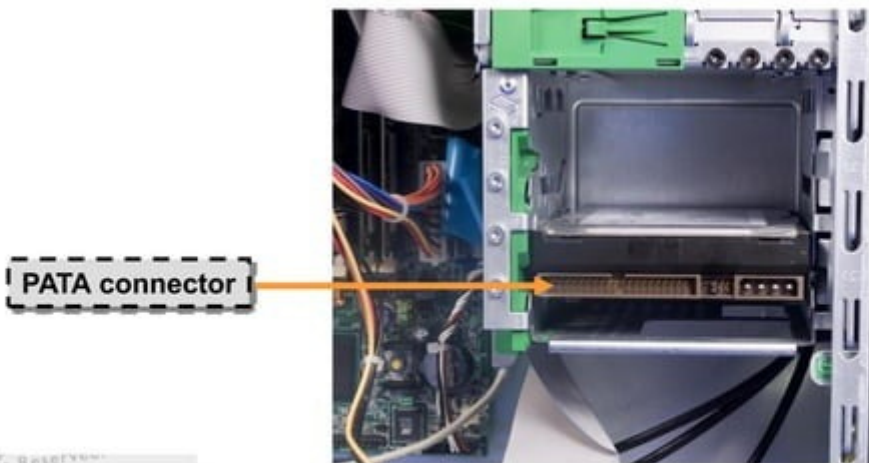

Serial ATA (SATA) Connections

A **SATA connection** is a personal computer connection that provides a serial data channel between the drive controller and the disk drives.

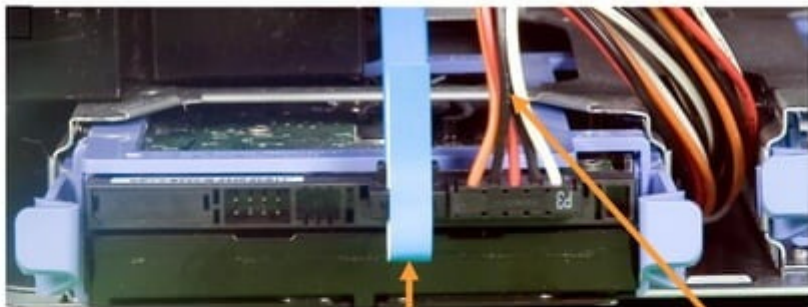

SATA data cable

SATA power cables